

353537-2 ✓ ACTIVE

AMP | Multilock Connector System

TE Internal #: 353537-2

Automotive Terminals, Tab, Mating Tab Width .039 in [1 mm], Tab Thickness .025 in [.64 mm], 22 – 20 AWG Wire Size, Multilock Connector System

[View on TE.com >](#)



Terminals & Splices > Automotive Terminals > MULTILOCK, RECEPTACLE AND TAB

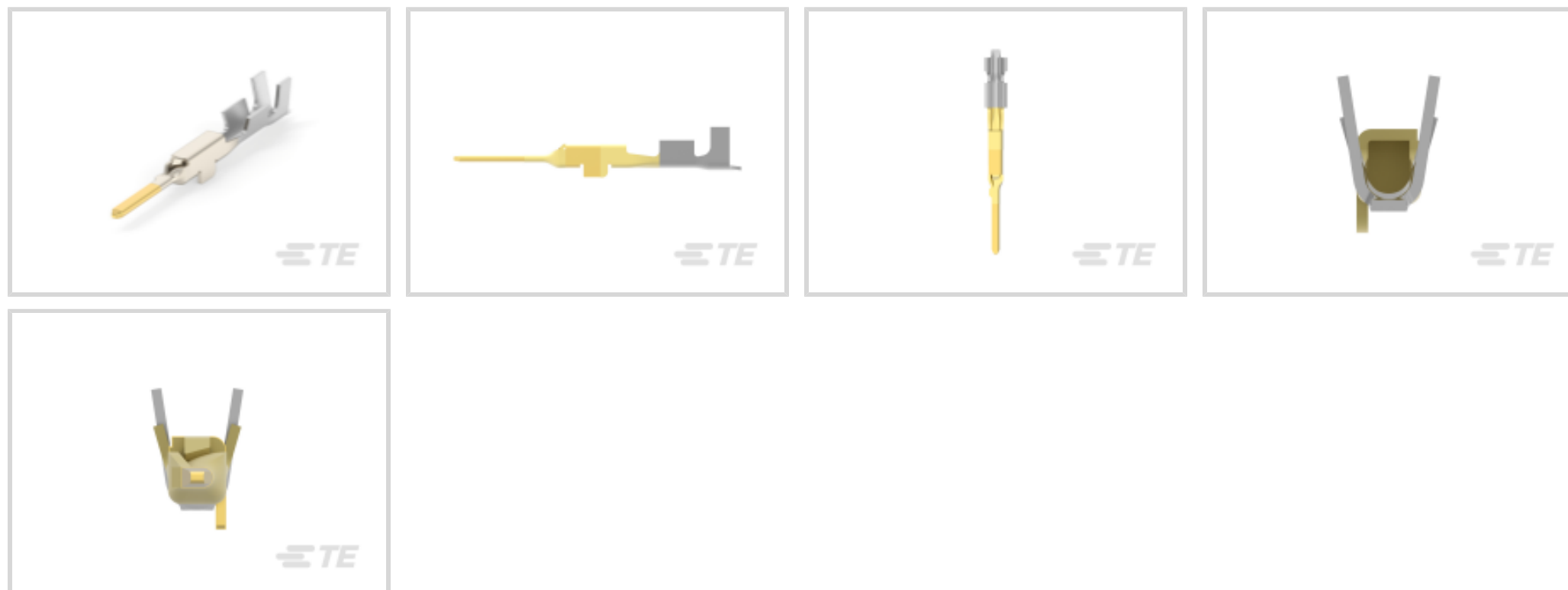

Terminal Type: **Tab**

Mating Tab Width: **1 mm [.039 in]**

Mating Tab Thickness: **.64 mm [.025 in]**

Terminal Transmits: **0 – 24 A (Low Power)**

Wire Size: **22 – 20 AWG**

[All MULTILOCK, RECEPTACLE AND TAB \(142\)](#)

Features

Product Type Features

Sealable	No
Primary Locking Feature	Clean Body

Contact Features

Contact Size	1mm
Contact Fabrication	Stamped & Formed
Crimp Type	F-Crimp
Terminal Type	Tab
Mating Tab Width	1 mm[.039 in]
Mating Tab Thickness	.64 mm[.025 in]
Interface Plating	Gold (Au)

Termination Features

Termination Method to Wire & Cable	Crimp
------------------------------------	-------



Product Terminates To

Wire

Dimensions

Wire Size	.3 – .5 mm ²
Wire Size Search	20 AWG, 21 AWG, 22 AWG
Wire Insulation Diameter	1.4 – 1.7 mm [.055 – .067 in]

Usage Conditions

Insulation Option	Uninsulated
Operating Temperature (Max)	80 °C, 85 °C, 90 °C, 100 °C, 105 °C [176 °F] [185 °F][194 °F][212 °F][221 °F]
Operating Temperature Range	-40 – 105 °C [-40 – 221 °F]

Packaging Features

Packaging Method	Reel
Packaging Quantity	5000

Other

Terminal Transmits	0 – 24 A (Low Power)
--------------------	----------------------

Product Compliance

[For compliance documentation, visit the product page on TE.com>](#)

EU RoHS Directive 2011/65/EU	Compliant
EU ELV Directive 2000/53/EC	Compliant
China RoHS 2 Directive MIIT Order No 32, 2016	No Restricted Materials Above Threshold
EU REACH Regulation (EC) No. 1907/2006	Current ECHA Candidate List: JUNE 2022 (224) Candidate List Declared Against: JUNE 2022 (224) Does not contain REACH SVHC
Halogen Content	Low Halogen - Br, Cl, F, I < 900 ppm per homogenous material. Also BFR/CFR/PVC Free
Solder Process Capability	Not applicable for solder process capability

Product Compliance Disclaimer

This information is provided based on reasonable inquiry of our suppliers and represents our current actual knowledge based on the information they provided. This information is subject to change. The part numbers that TE has identified as EU RoHS compliant have a maximum concentration of 0.1% by weight in homogenous materials for lead, hexavalent chromium, mercury, PBB, PBDE, DBP, BBP, DEHP, DIBP, and 0.01% for cadmium, or qualify for an exemption to these limits as defined in the Annexes of Directive 2011/65/EU (RoHS2). Finished electrical and electronic equipment products will be CE marked as required by Directive 2011/65/EU. Components may not be CE marked. Additionally, the part numbers that TE has identified as EU ELV compliant have a maximum concentration of 0.1% by weight in homogenous

materials for lead, hexavalent chromium, and mercury, and 0.01% for cadmium, or qualify for an exemption to these limits as defined in the Annexes of Directive 2000/53/EC (ELV). Regarding the REACH Regulation, the information TE provides on SVHC in articles for this part number is based on the latest European Chemicals Agency (ECHA) 'Guidance on requirements for substances in articles' posted at this URL: <https://echa.europa.eu/guidance-documents/guidance-on-reach>

Compatible Parts



TE Part # 2305570-1
Strip Terminal Cutter-Side Feed-No Crimp



TE Part # CAT-M9194-CH8172
MULTILOCK, CONNECTOR HOUSING



TE Part # 2-2151144-1
OCEAN_2.0_APPLICATOR-S-067F062F



TE Part # 2151144-1
OCEAN_2.0_APPLICATOR-S-067F062F



TE Part # 2-2151144-2
OCEAN_2.0_APPLICATOR-S-067F062FA



TE Part # 2-2836577-1
OCEAN-2.0-APPLICATOR-S-070F130F



TE Part # 2-2836577-2
OCEAN-2.0-APPLICATOR-S-070F130FA



TE Part # 2151144-2
OCEAN_2.0_APPLICATOR-S-067F062FA



TE Part # 2836577-1
OCEAN-2.0-APPLICATOR-S-070F130F



TE Part # 2836577-2
OCEAN-2.0-APPLICATOR-S-070F130FA



TE Part # 5-2151144-1
OCEAN_2.0_APPLICATOR-S-067F062F



TE Part # 5-2151144-2
OCEAN_2.0_APPLICATOR-S-067F062FA



TE Part # 7-2151144-1
OCEAN_2.0_APPLICATOR-S-067F062F



TE Part # 7-2151144-2
OCEAN_2.0_APPLICATOR-S-067F062FA



KIT
TE Part # 7-2151144-7
OCEAN_2.0_SPARE_PART_KIT-067F062F



KIT
TE Part # 7-2836564-7
OC-067F062F-752-CRIMPTOOLINGKIT

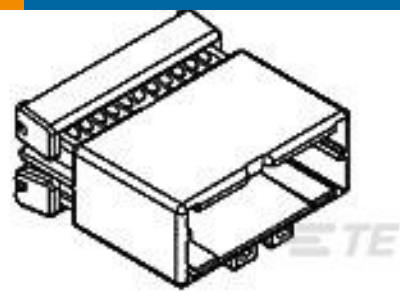

TE Part # 1123364-1
040-3 MLC CAP HSG ASSY 24P

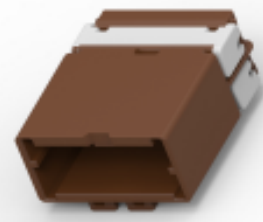

TE Part # 1123353-3
040 MLC CAP HSG ASSY 16P

Also in the Series | Multilock Connector System



Automotive Connector Caps & Covers
(16)



Automotive Connector EMC Shielding
(1)

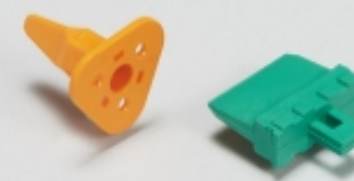

Automotive Connector Locks &
Position Assurance(2)



Automotive Housings(572)



Automotive Seals & Cavity Plugs(2)

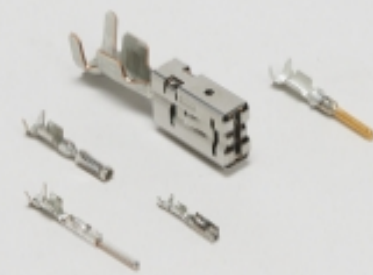

Automotive Terminals(140)



Insertion & Extraction Tools(6)

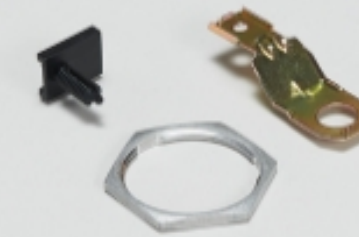

Other Automotive Connector
Accessories(9)

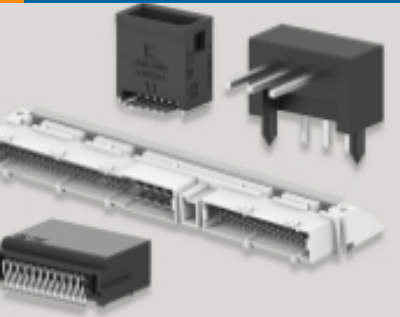

PCB Headers & Receptacles(127)

Documents

Product Drawings

040-3 UNSEALED CONT.TAB(S)GOLD

Japanese

CAD Files

3D PDF

3D

Customer View Model



[ENG_CVM_CVM_353537-2_G.2d_dxf.zip](#)

English

Customer View Model

[ENG_CVM_CVM_353537-2_G.3d_igs.zip](#)

English

Customer View Model

[ENG_CVM_CVM_353537-2_G.3d_stp.zip](#)

English

By downloading the CAD file I accept and agree to the [Terms and Conditions](#) of use.

Datasheets & Catalog Pages

MULTILOCK Connector System

English

Product Specifications

Crimping .040III Unsealed Contact, Tab

Japanese

Application Specification

Japanese

Crimping .040III Unsealed Contact, Tab

Japanese

Application Specification

Japanese